

Sitzilia 40 (380x656)

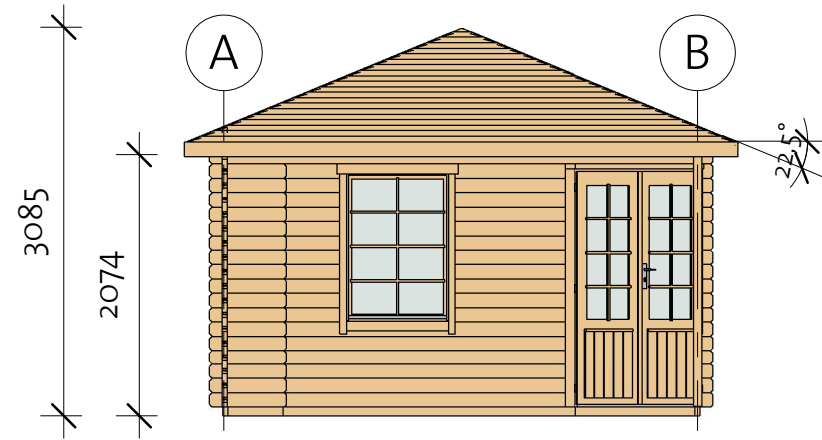

Sitzilia 40 (380x656)

Foundation

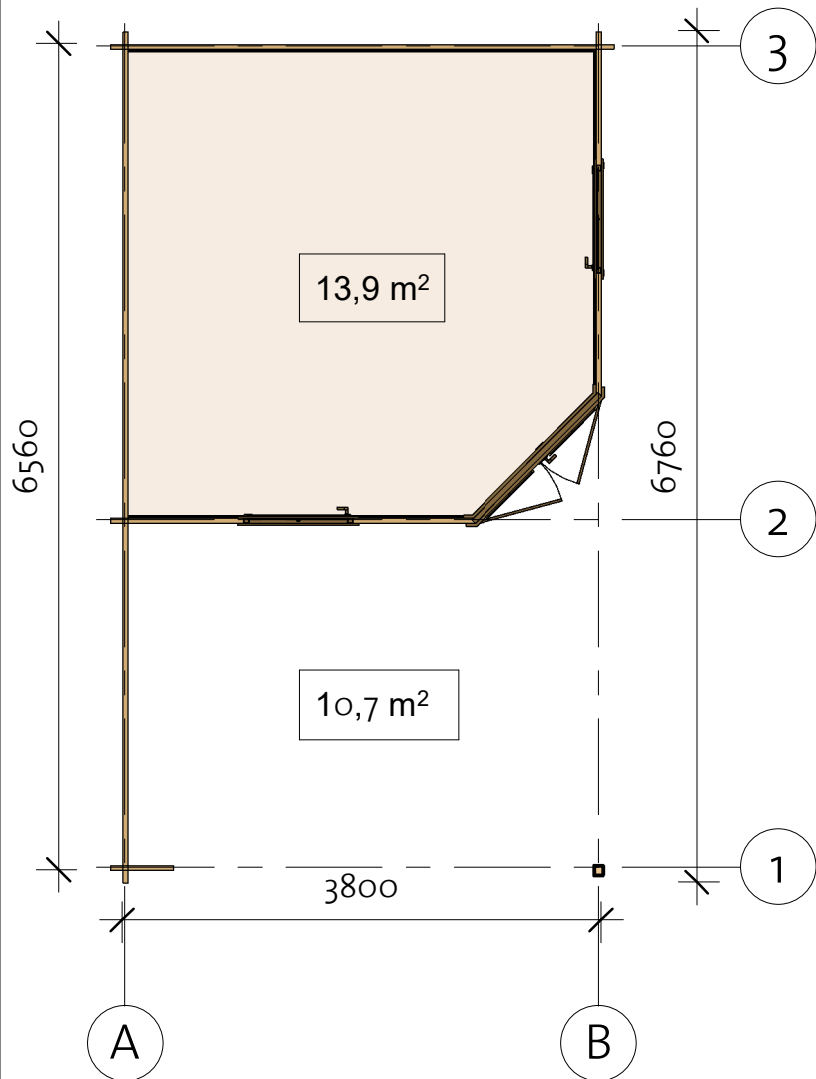
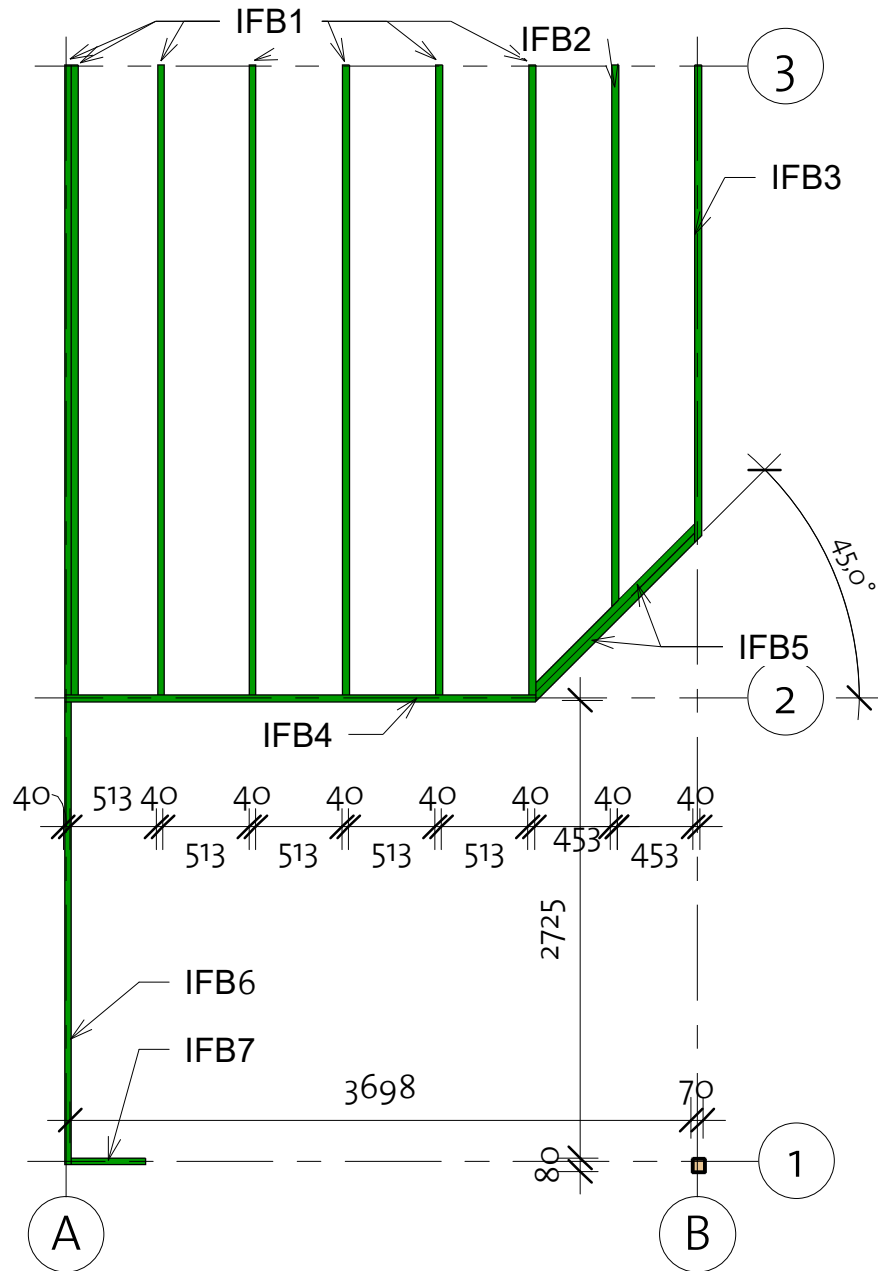

Impregnated foundation beams				
Mark	Type	Profile	Count	Length

IFB1	IFB 40x70		7	3750
IFB2	IFB 40x70		1	3224
IFB3	IFB 40x70		1	2845
IFB4	IFB 40x70		1	2805
IFB5	IFB 40x70		2	1376
IFB6	IFB 40x70		1	2760
IFB7	IFB 40x70		1	440

Sitzilia 40 (380x656)

Floor Plan

① Baseboard

Floor Schedule

Mark	Type	Profile	Count	Length
------	------	---------	-------	--------

FB 1	FB 17x114		1	2844
FB 2	FB 17x114		1	2958
FB 3	FB 17x114		1	3072
FB 4	FB 17x114		1	3186
FB 5	FB 17x114		1	3300
FB 6	FB 17x114		1	3414
FB 7	FB 17x114		1	3528
FB 8	FB 17x114		1	3642
FB 9	FB 17x114		1	3717
FB 10	FB 17x114		25	3717

BB	BB 20x40		4	3800
----	----------	---	---	------

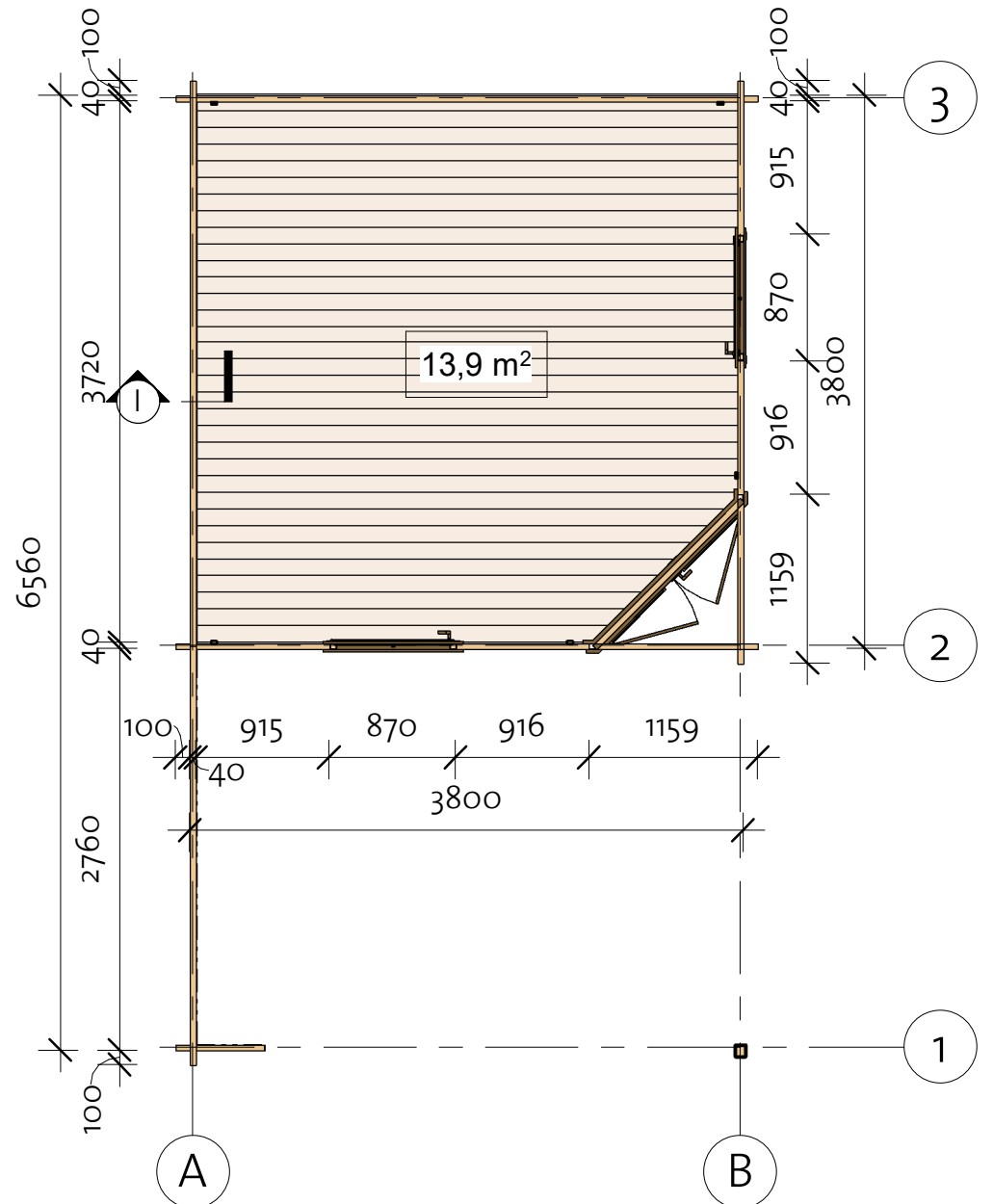
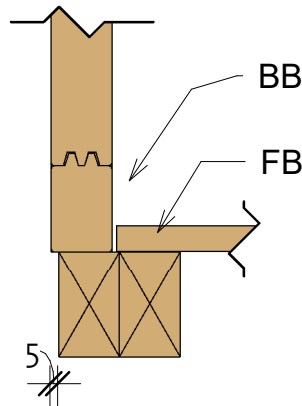

Sitzilia 40 (380x656)

Wall 1

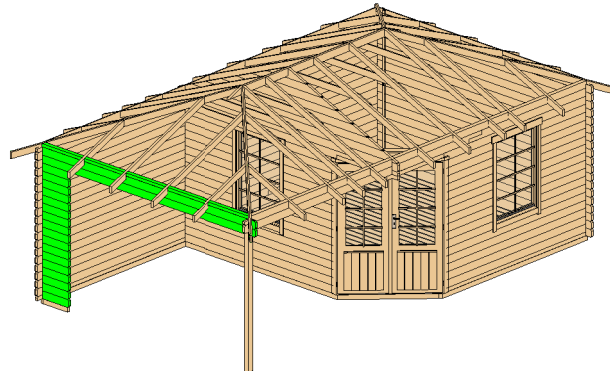

Wall 1			
Mark	Profile	Count	Cut Length

1LG-1	40x114	17	610
1LG-2	40x114	1	4000
1LG-3	40x114	1	4000
1TL-1	40x63	3	711
1TL-2	40x63	1	725
1TL-3	40x63	1	725

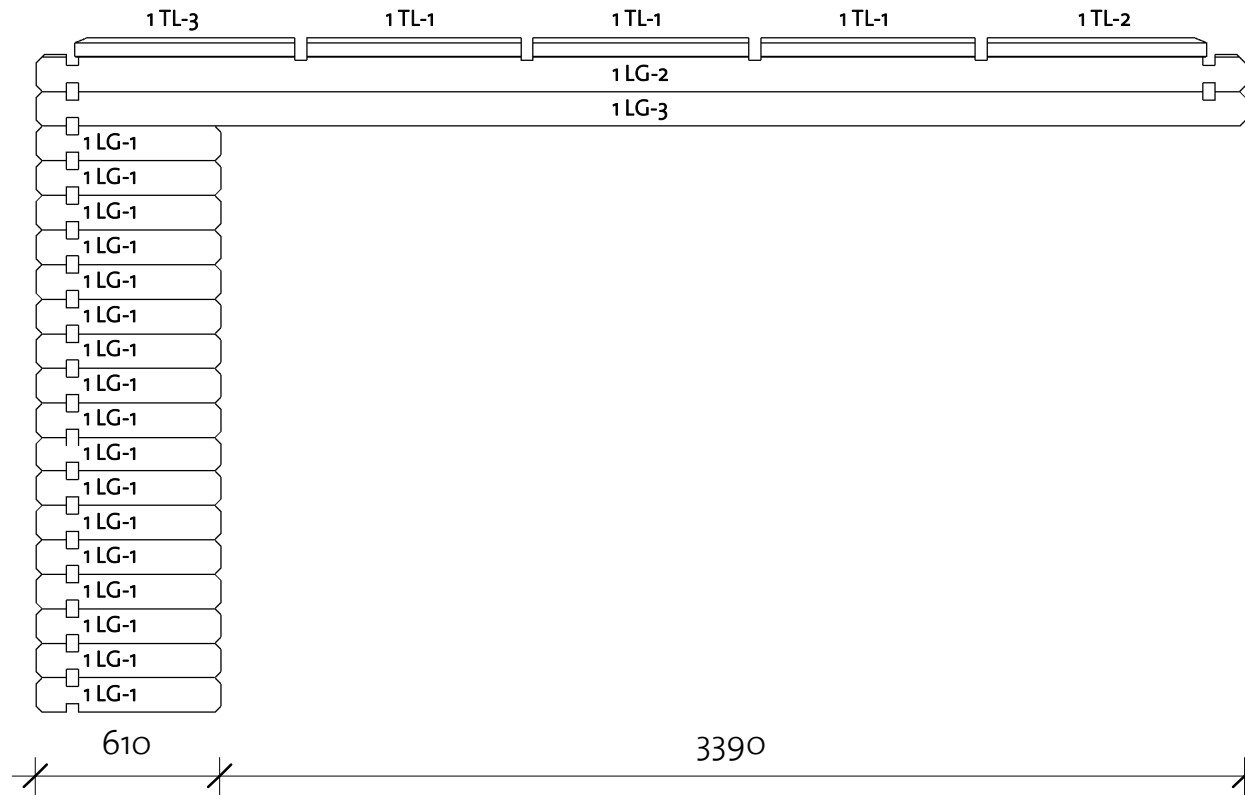

Log Profile Wall 1	
Profile	Profile

40x114	
40x63	

Sitzilia 40 (380x656)

Wall 2

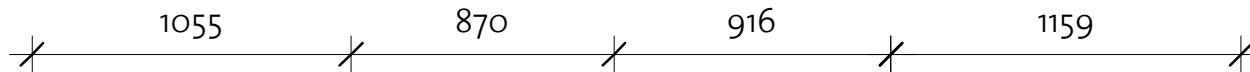
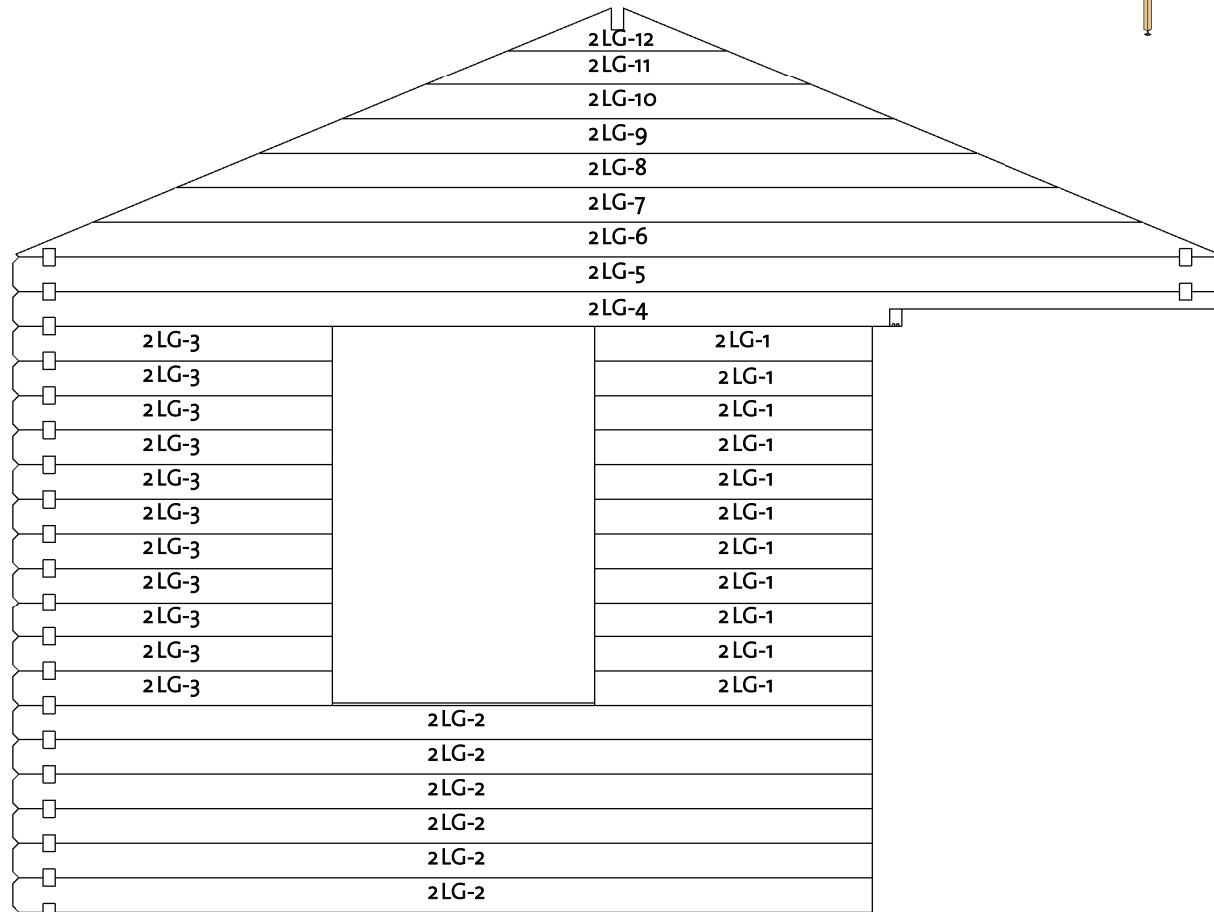
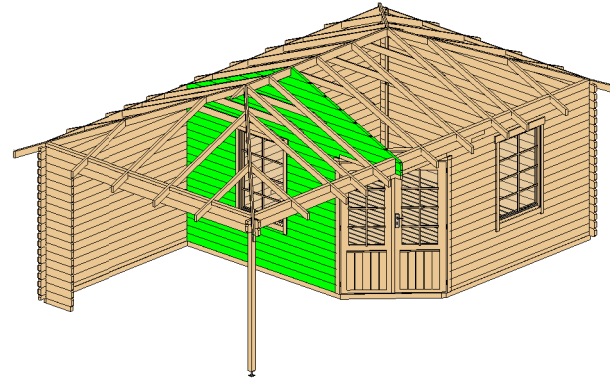

920704211_211019

Wall 2			
Mark	Profile	Count	Cut Length

2LG-1	40X114	11	916
2LG-2	40X114	6	2841
2LG-3	40X114	11	1055
2LG-4	40X114	1	4000
2LG-4/M	40X114	1	4000
2LG-5 *	40X114	1	4000
2LG-6 *	40X114	1	3979
2LG-7 *	40X114	1	3474
2LG-8 *	40X114	1	2923
2LG-9 *	40X114	1	2373
2LG-10*	40X114	1	1822
2LG-11 *	40X114	1	1272
2LG-12*	40X141	1	722

* Gable - delivered premounted

Log Profile Wall 2	
Profile	Profile

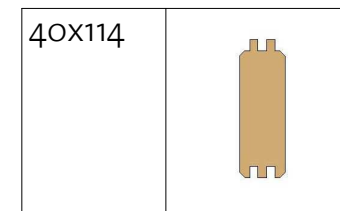

Log Profile Wall 2	
Profile	Profile

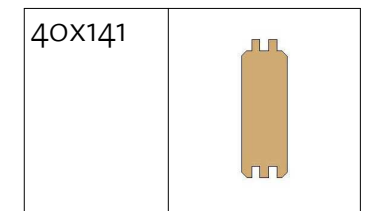

Sitzilia 40 (380x656)

Wall 3

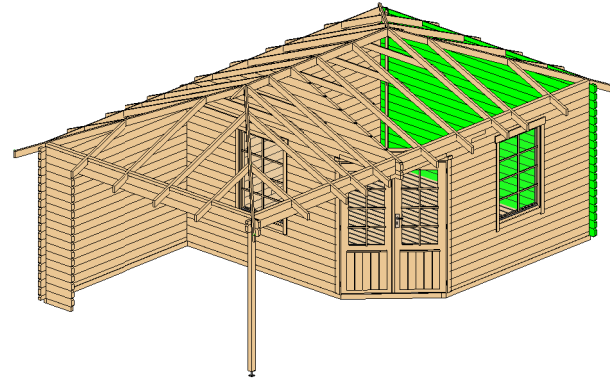

Wall 3			
Mark	Profile	Count	Cut Length

3LG-1	40x114	18	4000
3LG-2	40x114	1	4000
3TL-1	40x63	3	711
3TL-2	40x63	1	725
3TL-3	40x63	1	725

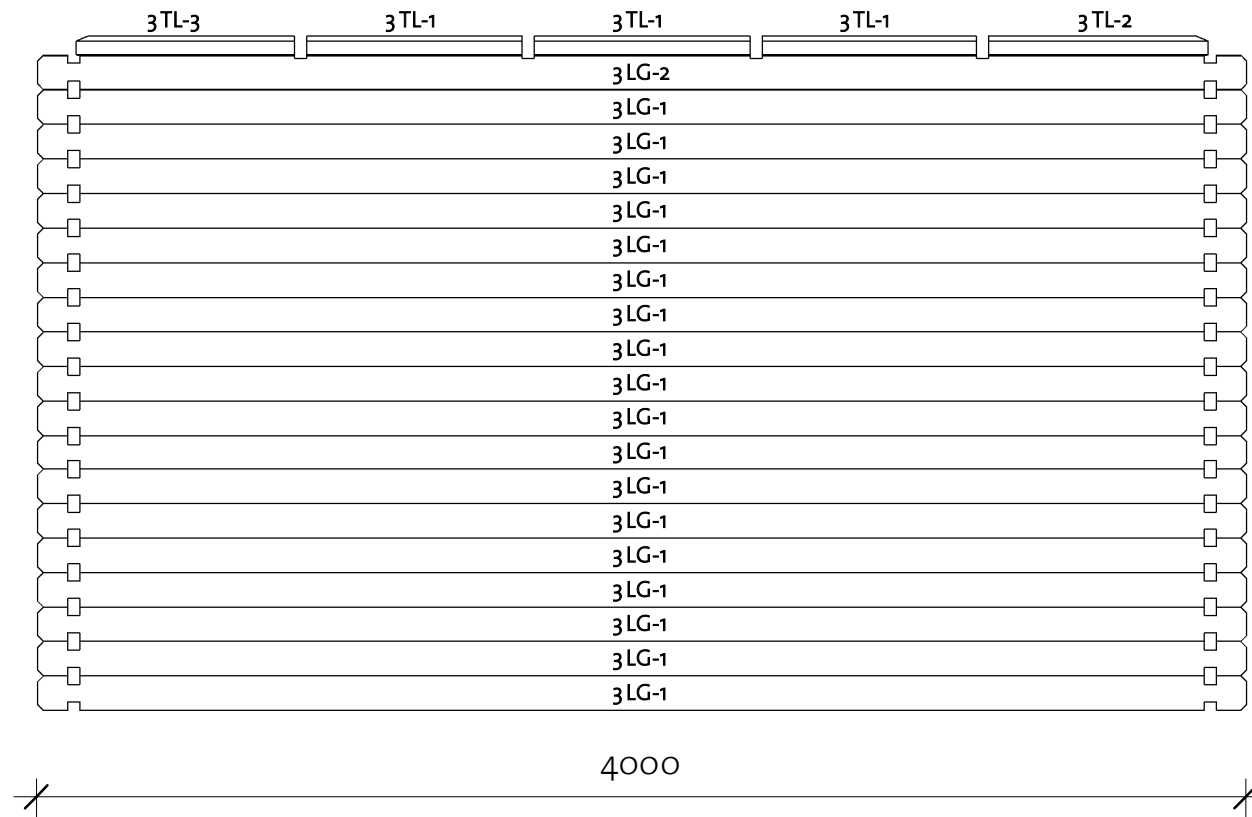

Log Profile Wall 3	
Profile	Profile

40x114	
40x63	

Sitzilia 40 (380x656)

Wall A

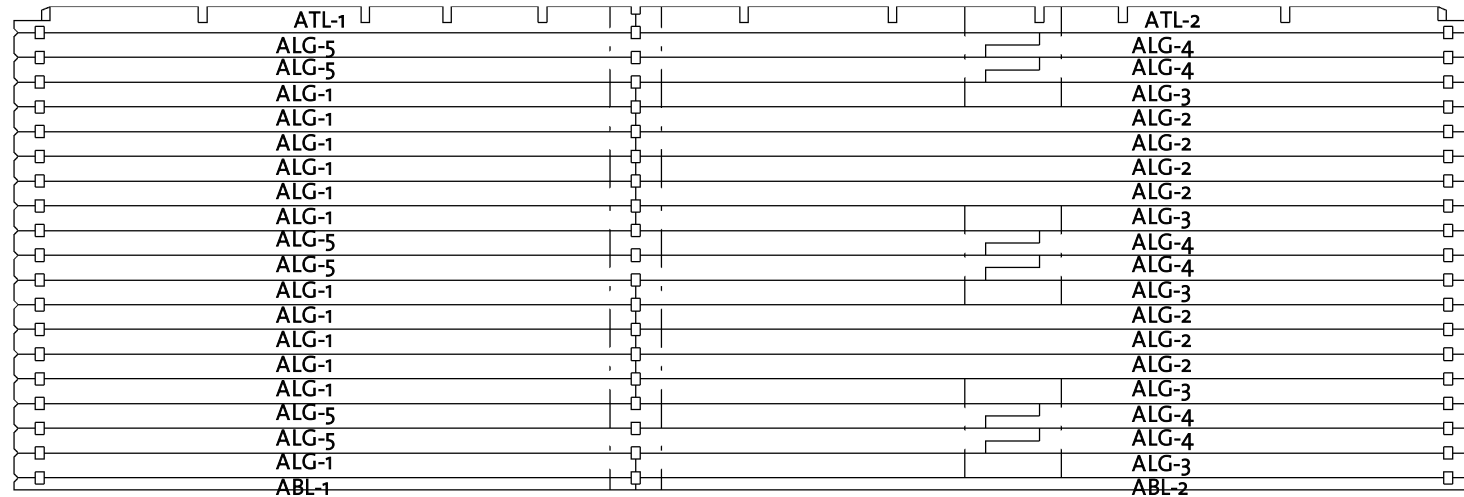
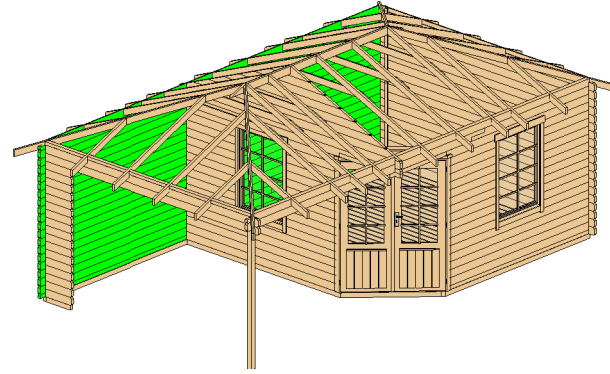

Wall A			
Mark	Profile	Count	Cut Length

ABL-1	40x57	1	2880
ABL-2	40x57	1	3880
ALG-1	40x114	12	2880
ALG-2	40x114	7	3880
ALG-3	40x114	5	3880
ALG-4	40x114	6	2260
ALG-5	40x114	6	4750
ATL-1	40x120	1	2880
ATL-2	40x120	1	3880

Log Profile Wall A	
Profile	Profile

Log Profile Wall A	
Profile	Profile

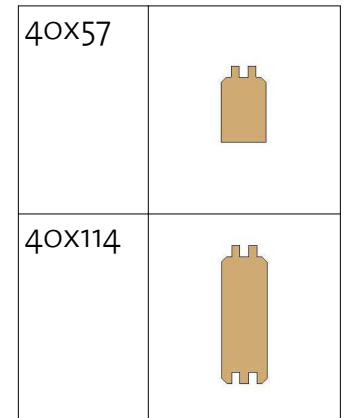
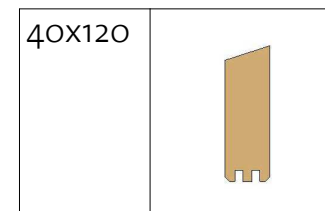

Sitzilia 40 (380x656)

Wall B

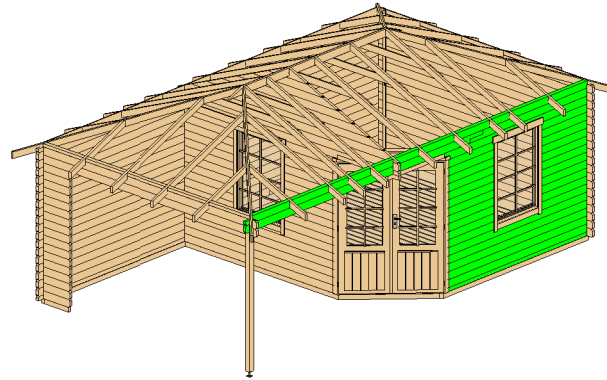

Wall B			
Mark	Profile	Count	Cut Length

BBL-1	40X57	1	2841
BLG-1	40X114	10	916
BLG-2	40X114	10	1055
BLG-3	40X114	1	2841
BLG-4	40X114	5	2841
BLG-5	40X114	1	2938
BLG-5/M	40X114	1	2938
BLG-6	40X114	1	2410
BLG-7	40X114	1	4600
BTL-1	40X120	1	2880
BTL-2	40X120	1	3880

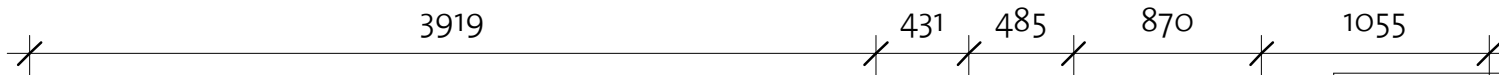
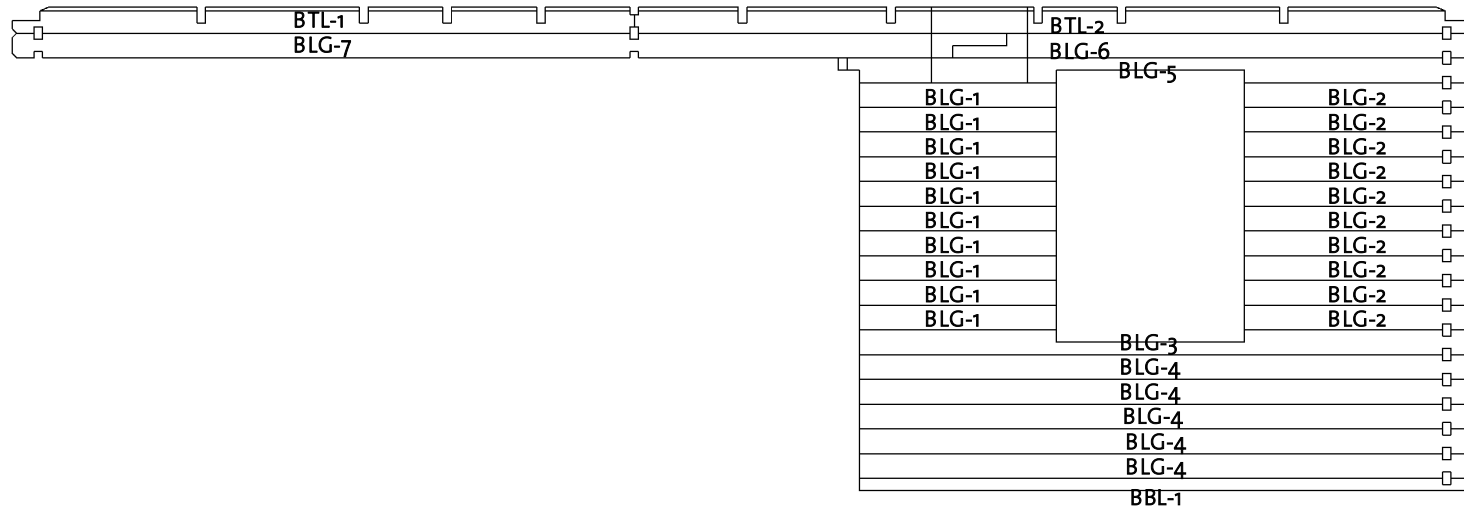

Log Profile Wall B	
Profile	Profile

Log Profile Wall B	
Profile	Profile

40X120	
--------	--

40X57	
40X114	

Sitzilia 40 (380x656)

Roof 1

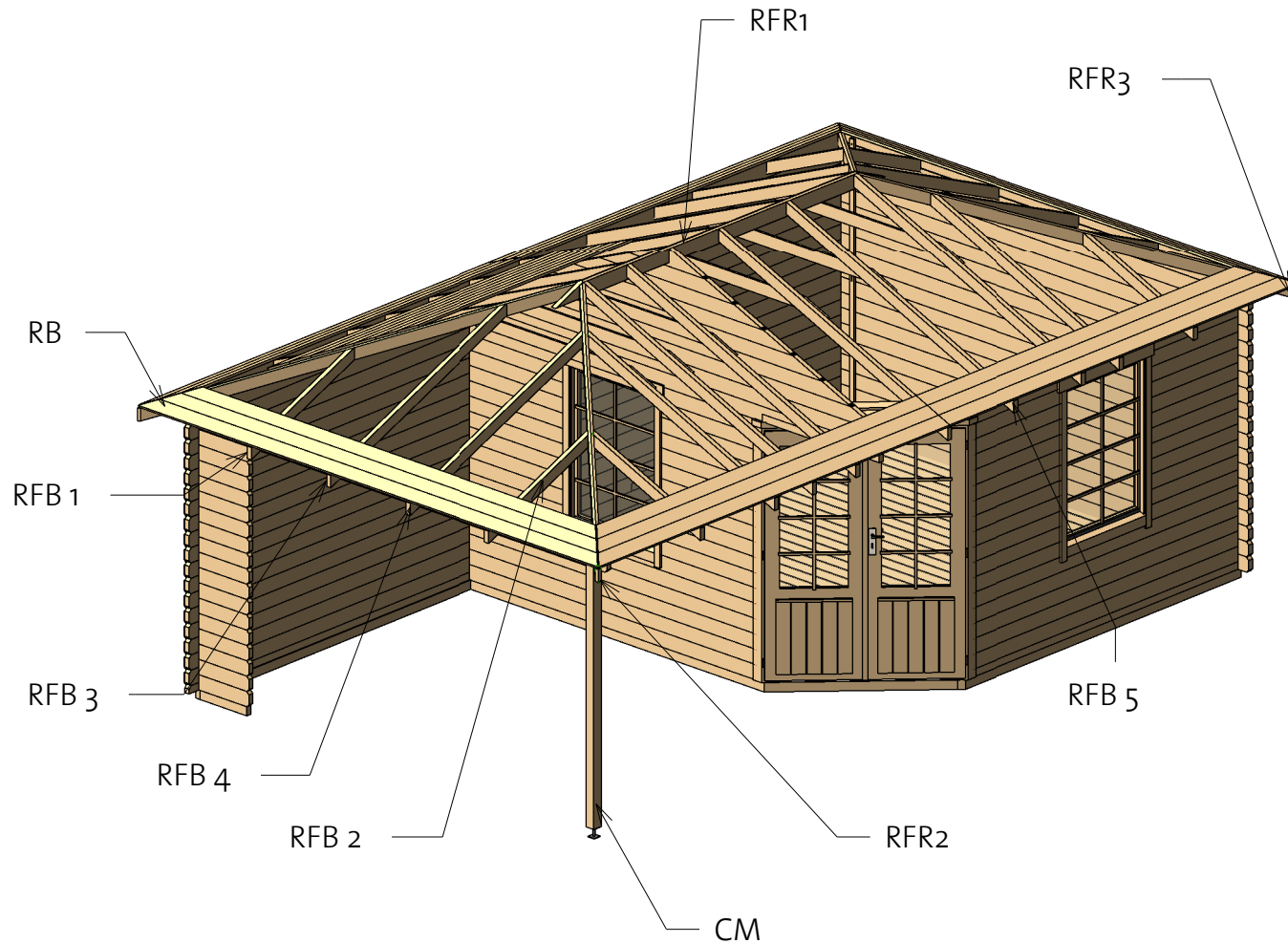

Roof				
Mark	Type	Profile	Count	Length

RFB1	40x85		4	1166
RFB2	40x85		4	1166
RFB3	40x85		4	1979
RFB4	40x85		4	1979
RFB5	40x85		10	2373
RFC	18x95		6	2025
RFR1	40x120		1	3339
RFR2	40x94		2	3217
RFR3	40x94		2	3217

Columns			
Mark	Type	Length	Count

CM	Post 80x70	1990	1
----	------------	------	---

Sitzilia 40 (380x656)

Roof 2

Roofboards				
Mark	Type	Profile	Count	Length

RB1	RoofBoard 17x114		2	134
RB2	RoofBoard 17x114		2	345
RB3	RoofBoard 17x114		2	555
RB4	RoofBoard 17x114		2	766
RB5	RoofBoard 17x114		2	977
RB6	RoofBoard 17x114		2	1187
RB7	RoofBoard 17x114		2	1398
RB8	RoofBoard 17x114		2	1609
RB9	RoofBoard 17x114		2	1819
RB10	RoofBoard 17x114		2	2030
RB11	RoofBoard 17x114		2	2240
RB12	RoofBoard 17x114		2	2451
RB13	RoofBoard 17x114		2	2662
RB14	RoofBoard 17x114		2	2872
RB15	RoofBoard 17x114		2	3083
RB16	RoofBoard 17x114		2	3294
RB17	RoofBoard 17x114		2	3504
RB18	RoofBoard 17x114		2	3715
RB19	RoofBoard 17x114		2	3926
RB20	RoofBoard 17x114		2	4136

Roofboards				
Mark	Type	Profile	Count	Length

RB21	RoofBoard 17x114		2	4347
RB22	RoofBoard 17x114		2	2894
RB23	RoofBoard 17x114		2	3105
RB24	RoofBoard 17x114		2	3315
RB25	RoofBoard 17x114		2	3526
RB26	RoofBoard 17x114		2	3737
RB27	RoofBoard 17x114		2	3947
RB28	RoofBoard 17x114		2	4158
RB29	RoofBoard 17x114		2	4369
RB30	RoofBoard 17x114		4	2290
RB31	RoofBoard 17x114		4	2395
RB32	RoofBoard 17x114		4	2500
RB33	RoofBoard 17x114		4	2606
RB34	RoofBoard 17x114		4	2711
RB35	RoofBoard 17x114		4	2816
RB36	RoofBoard 17x114		4	2922
RB37	RoofBoard 17x114		4	3027
RB38	RoofBoard 17x114		4	3132
RB39	RoofBoard 17x114		4	3238
RB40	RoofBoard 17x114		4	3343
RB41	RoofBoard 17x114		4	3448
RB42	RoofBoard 17x114		4	3553

Sitzilia 40 (380x656)

Roof 3

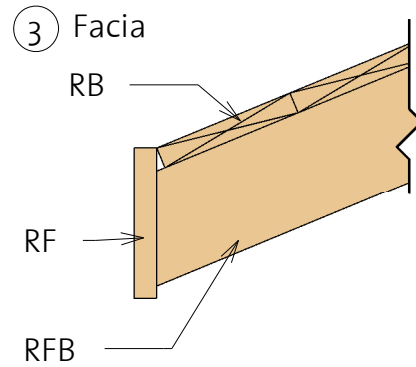
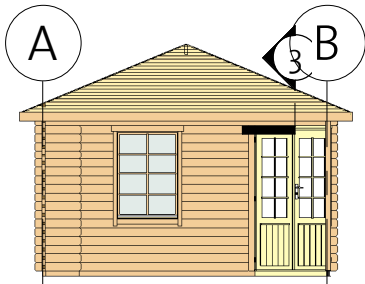

Fascia Schedule				
Mark	Type	Profile	Count	Length
RF1	Roof Fascia 18x120		2	4396
RF2	Roof Fascia 18x120		4	3560

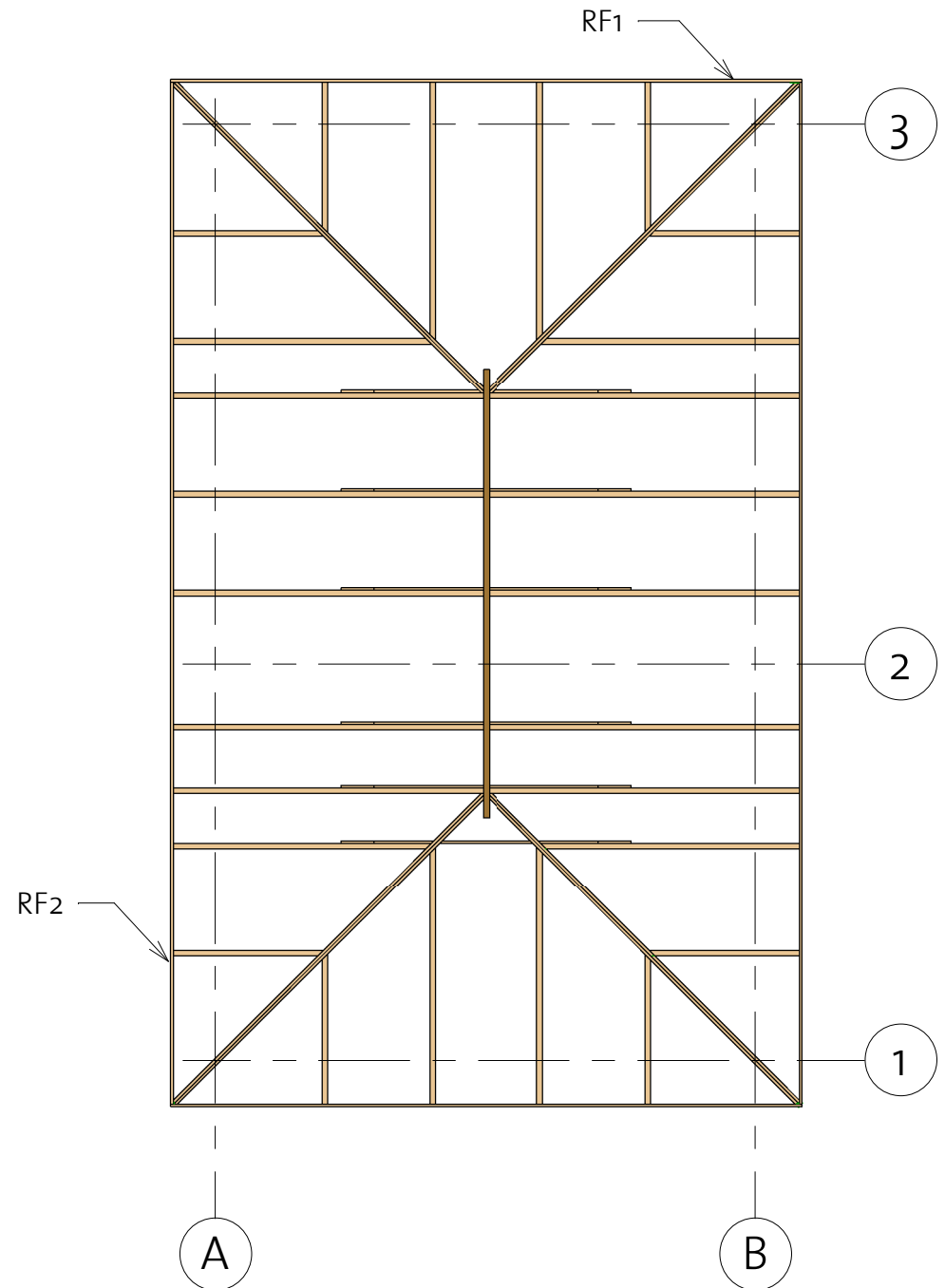

Sitzilia 40 (380x656)

Extras

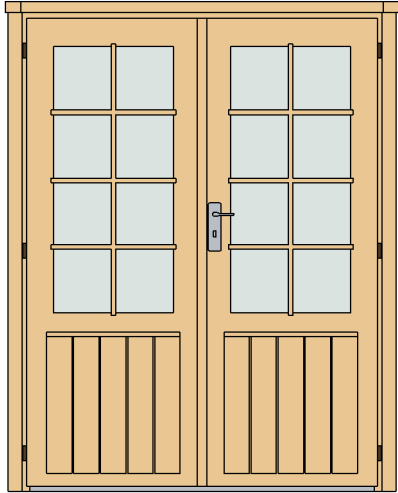

Door Schedule				
Model	Type	Width	Height	Count
CDD7R	Classic double door 7 right	1425	1900	1

Window Schedule				
Model	Type	Width	Height	Count
CW2L	Classic window 2 left	865	1210	1
CW2R	Classic window 2 right	865	1210	1

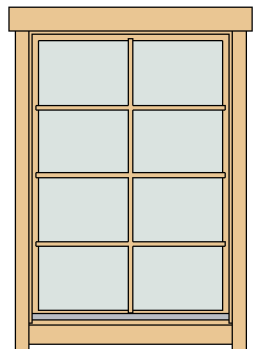

- * Windows intended for tilt opening only!
- * Fenster zur Eröffnung nur zum Kippen vorgesehen!
- * Aknad on ette nähtud ainult kaldu avamiseks!

920704211_211019



Type	Count	Length
Windboard 18x40	6	2200

Fasteners/Extras		
Name	Type	Count

Hitblock	300-400 mm	
Adjustable post foot		1
Bolts	M8 x 70	18
Nails	1,4 x 40	40
Dowels	16,0 150	55
Screws	5,0 x 70	70
Screws	6,0 x 140	120
Screws	4,0 x 40	1080

① Roof top

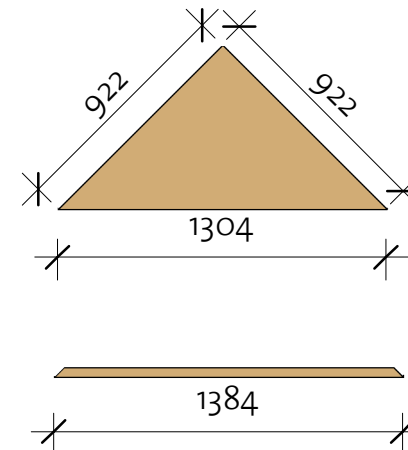

Type	Mark	Count
------	------	-------

Ceiling detail 40x120	CD	1
Ceiling triangle	CT	1



Sitzilia 40 (380x656)

List of all items 1

Impregnated foundation beams

Mark	Type	Profile	Count	Length
IFB1	IFB 40x70		7	3750
IFB2	IFB 40x70		1	3224
IFB3	IFB 40x70		1	2845
IFB4	IFB 40x70		1	2805
IFB5	IFB 40x70		2	1376
IFB6	IFB 40x70		1	2760
IFB7	IFB 40x70		1	440

Fascia Schedule

Mark	Type	Profile	Count	Length
RF1	Roof Fascia 18x120		2	4396
RF2	Roof Fascia 18x120		4	3560

Columns



Mark	Type	Length	Count
CM	Post 80x70	1990	1

Floor Schedule

Mark	Type	Profile	Count	Length
FB 1	FB 17x114		1	2844
FB 2	FB 17x114		1	2958
FB 3	FB 17x114		1	3072
FB 4	FB 17x114		1	3186
FB 5	FB 17x114		1	3300
FB 6	FB 17x114		1	3414
FB 7	FB 17x114		1	3528
FB 8	FB 17x114		1	3642
FB 9	FB 17x114		1	3717
FB 10	FB 17x114		25	3717

BB	BB 20x40		4	3800
----	----------	---	---	------

Roof

Mark	Type	Profile	Count	Length
RFB1	40x85		4	1166
RFB2	40x85		4	1166
RFB3	40x85		4	1979
RFB4	40x85		4	1979
RFB5	40x85		10	2373
RFC	18x95		6	2025
RFR1	40x120		1	3339
RFR2	40x94		2	3217
RFR3	40x94		2	3217

Sitzilia 40 (380x656)

List of all items 2

Wall 1			
Mark	Profile	Count	Cut Length

1LG-1	40X114	17	610
1LG-2	40X114	1	4000
1LG-3	40X114	1	4000
1TL-1	40X63	3	711
1TL-2	40X63	1	725
1TL-3	40X63	1	725

Wall 2			
Mark	Profile	Count	Cut Length

2LG-1	40X114	11	916
2LG-2	40X114	6	2841
2LG-3	40X114	11	1055
2LG-4	40X114	1	4000
2LG-4/ M	40X114	1	4000
2LG-5 *	40X114	1	4000
2LG-6 *	40X114	1	3979
2LG-7 *	40X114	1	3474
2LG-8 *	40X114	1	2923
2LG-9 *	40X114	1	2373
2LG-10*	40X114	1	1822
2LG-11*	40X114	1	1272
2LG-12*	40X141	1	722

* Gable - delivered premounted

Wall 3			
Mark	Profile	Count	Cut Length

3LG-1	40X114	18	4000
3LG-2	40X114	1	4000
3TL-1	40X63	3	711
3TL-2	40X63	1	725
3TL-3	40X63	1	725

Sitzilia 40 (380x656)

List of all items 3



Wall A			
Mark	Profile	Count	Cut Length

ABL-1	40x57	1	2880
ABL-2	40x57	1	3880
ALG-1	40x114	12	2880
ALG-2	40x114	7	3880
ALG-3	40x114	5	3880
ALG-4	40x114	6	2260
ALG-5	40x114	6	4750
ATL-1	40x120	1	2880
ATL-2	40x120	1	3880



Wall B			
Mark	Profile	Count	Cut Length

BBL-1	40x57	1	2841
BLG-1	40x114	10	916
BLG-2	40x114	10	1055
BLG-3	40x114	1	2841
BLG-4	40x114	5	2841
BLG-5	40x114	1	2938
BLG-5/M	40x114	1	2938
BLG-6	40x114	1	2410
BLG-7	40x114	1	4600
BTL-1	40x120	1	2880
BTL-2	40x120	1	3880

Log Profiles	
Profile	Profile

40x114	
40x141	

Log Profiles	
Profile	Profile

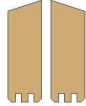
40x63	
40x57	
40x120	

Sitzilia 40 (380x656)

List of all items 4

Roofboards				
Mark	Type	Profile	Count	Length

RB1	RoofBoard 17x114		2	134
RB2	RoofBoard 17x114		2	345
RB3	RoofBoard 17x114		2	555
RB4	RoofBoard 17x114		2	766
RB5	RoofBoard 17x114		2	977
RB6	RoofBoard 17x114		2	1187
RB7	RoofBoard 17x114		2	1398
RB8	RoofBoard 17x114		2	1609
RB9	RoofBoard 17x114		2	1819
RB10	RoofBoard 17x114		2	2030
RB11	RoofBoard 17x114		2	2240
RB12	RoofBoard 17x114		2	2451
RB13	RoofBoard 17x114		2	2662
RB14	RoofBoard 17x114		2	2872
RB15	RoofBoard 17x114		2	3083
RB16	RoofBoard 17x114		2	3294
RB17	RoofBoard 17x114		2	3504
RB18	RoofBoard 17x114		2	3715
RB19	RoofBoard 17x114		2	3926
RB20	RoofBoard 17x114		2	4136

Roofboards				
Mark	Type	Profile	Count	Length

RB21	RoofBoard 17x114		2	4347
RB22	RoofBoard 17x114		2	2894
RB23	RoofBoard 17x114		2	3105
RB24	RoofBoard 17x114		2	3315
RB25	RoofBoard 17x114		2	3526
RB26	RoofBoard 17x114		2	3737
RB27	RoofBoard 17x114		2	3947
RB28	RoofBoard 17x114		2	4158
RB29	RoofBoard 17x114		2	4369
RB30	RoofBoard 17x114		4	2290
RB31	RoofBoard 17x114		4	2395
RB32	RoofBoard 17x114		4	2500
RB33	RoofBoard 17x114		4	2606
RB34	RoofBoard 17x114		4	2711
RB35	RoofBoard 17x114		4	2816
RB36	RoofBoard 17x114		4	2922
RB37	RoofBoard 17x114		4	3027
RB38	RoofBoard 17x114		4	3132
RB39	RoofBoard 17x114		4	3238
RB40	RoofBoard 17x114		4	3343
RB41	RoofBoard 17x114		4	3448
RB42	RoofBoard 17x114		4	3553

Windboard

① Windboard Assembly 1



② Windboard Assembly 2

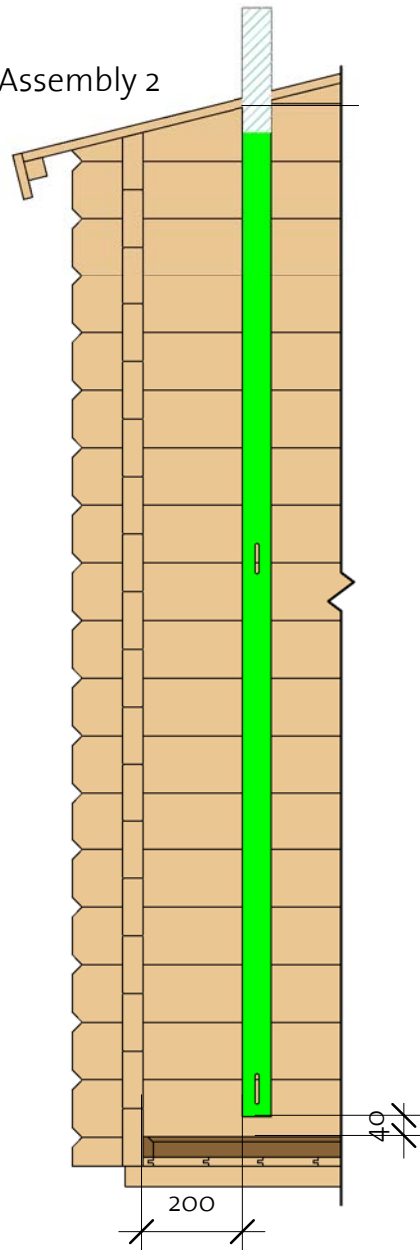

③ Windboard Assembly 3

